

1"1/2 (ND32) ATCOTM Airline BSP threaded ball valve - AD3X

The Perolo 1 1/2" ATCOTM ball valve is designed to be used as an air inlet or as a fluid inlet/outlet valve. With a super compact design, the 1 1/2" ATCOTM is light & economic.



Specifications

Nominal diameter	32 mm (1"1/4)
Weight	1.2 Kg
Inlet flange drilling	4 holes x \varnothing 11 x 103.5 PCD
Outlet connection	1"1/2 BSP or 1"1/2 NPT
Working Pressure (MAWP)	7 Bar
Test Pressure	10 Bar
Working Temperature	-40° to +130°C

Features

Made of (material)	316 / 1.4408 / CF8M
Compact design	Face to face 94 mm with cap
Maintenance	Easy filter change
Handling operation	1/4 turn
Ball seals material	PTFE

Options

Custom Drilling	on request
Cap & chain	with or without
Made of hastelloy for high corrosive environment	Serie AD3H7T
Gauge connection and/or protection	with or without
Filter	with or without
Pneumatic operating	Serie AP3X
Remote control system	with or without
High Temperature Version	on request
(working temperature: -40° to +250°C)	

Conformity & Certifications

Comply with	ADR / IMDG / RID / EN14432
Approved by	Bureau Veritas

Accessories

Part n°

Weld-in flange	11 90 20 00 00
Recess flange	11 91 12 00 00
Screw kit	12 91 99 00 00
Filter	11 14 01 95 00
Remote control with cable	RMT33 (3 meters)
<i>Other cable lenght on request</i>	
Remote control handle	11 14 15 91 00
Pressure gauge	70 21 02 00 22
1"1/2 BSP Cap	11 14 01 30 00
1"1/2 NPT Cap	12 96 03 00 00

Drawing

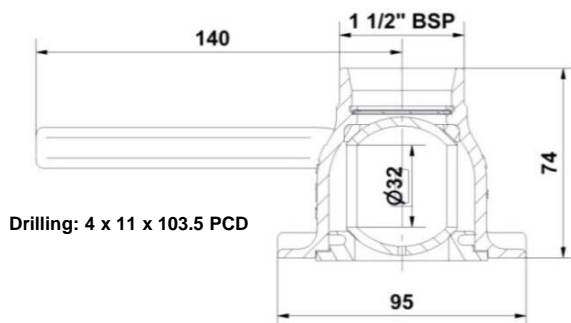

CAP AND GAUGE PROTECTION OPTION

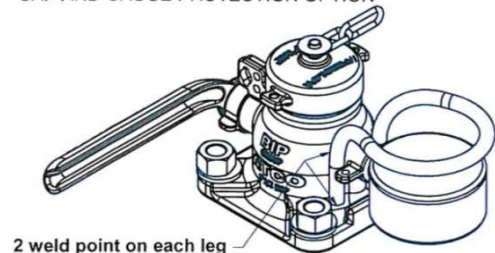

1"1/2 (ND32) ATCO™ Airline BSP threaded ball valve - AD3X

AIRLINE

Codification

1. Base code

AD3?7T ? ? ? ? ? ?

2. Material

- 316 / 1.4408 CF8M Stainless steel
- Hastelloy C276
- Carbon steel WCB (on request)
- 304L / 1.4306 stainless st. (on request)
- 904L / 1.4539 stainless st. (on request)

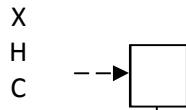

2. Inlet flange drilling

4 x Ø10.5 x 103.5 PCD

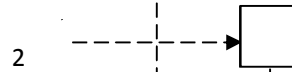

3. Cap

- without
- with
- with reinforced chain

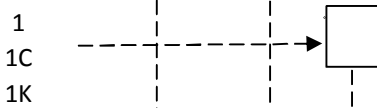

4. Filter

- without
- with

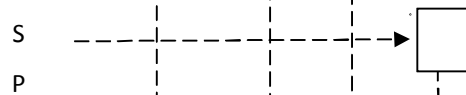

5. Gauge connection & plug

1/4" BSP gauge connection

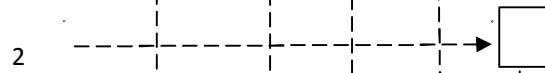

6. Gauge guard

- without
- with

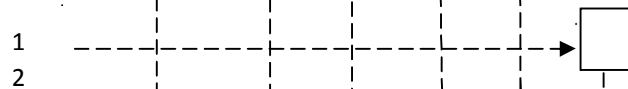

7. Remote control system

- with remote control handle
- without

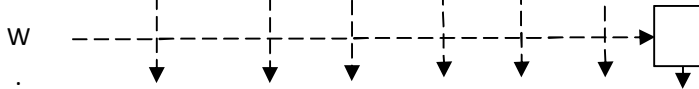

Standard Part Number

AD3X7T 2 1C S 2 1